

# Tromso FM 5

Capacity Per Linear Ft (lbs)  
**90–410\***

Shelf Depth Range (in)  
**4–12**

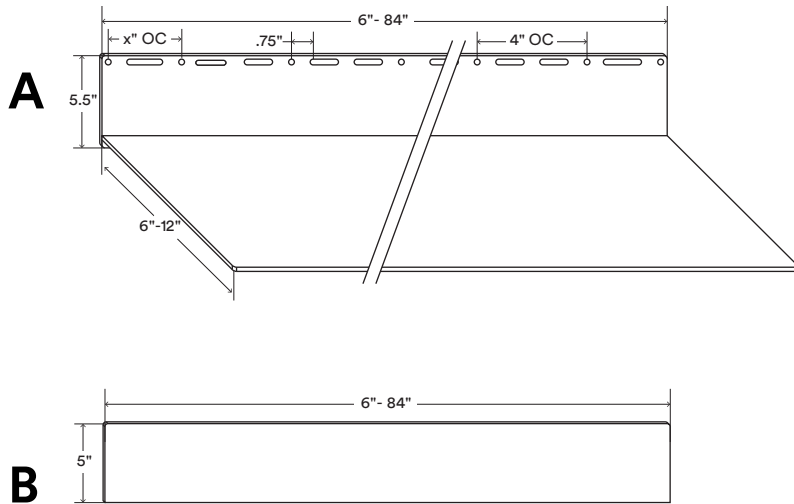

## About Tromso FM 5

Back bar is .25" thick, hot-rolled steel.

Set-through backbar construction hides welds for a clean look and insane strength.

The first screw holes start .3125" (1/8") on center (OC) from each end. Distance between first and second screw hole (X) varies upon shelf length. Holes continue 4" OC down the length of the shelf.

Countersunk screw holes are .1875" (3/16") outside diameter (OD).

Shelf weight is 0.1 lbs per square inch.

Cover plate made with 14 gauge steel.

Manufactured from top-quality American steel made with 70% recycled content.

Designed and produced in beautiful middle-of-nowhere Idaho, with sweat, tears, and Ameri-quality awesomeness.

Shelfology radically recycles all production metal, wood and cardboard waste.

**\*WARNING:** All shelves must be installed into studs or posts. Failure to do so may result in saggy shelves, falling objects, or even injury.

\*\*Drawings are representations only and not to scale.

© Shelfology 2023

Figure	Load Per Linear Foot	Shelf Depth	Shelf Length	Back Bar	Shelf Thickness
A	410 lbs	4"	6"–84"	5.5" high	.25"
A	370 lbs	5"	6"–84"	5.5" high	.25"
A	330 lbs	6"	6"–84"	5.5" high	.25"
A	290 lbs	7"	6"–84"	5.5" high	.25"
A	250 lbs	8"	6"–84"	5.5" high	.25"
A	210 lbs	9"	6"–84"	5.5" high	.25"
A	170 lbs	10"	6"–84"	5.5" high	.25"
A	130 lbs	11"	6"–84"	5.5" high	.25"
A	90 lbs	12"	6"–84"	5.5" high	.25"
B	NA	NA	6"–84"	5" high	NA