

Shelfology
Certified Rad_

Made In The U.S.A.
By Woodworkers, For
Woodworkers_

|
→ Patent
Pending
Design.

|
⚡ Lightning
Fast Lead
Times.

|
★ Made
In The
USA.

Studly FM

Install Guide

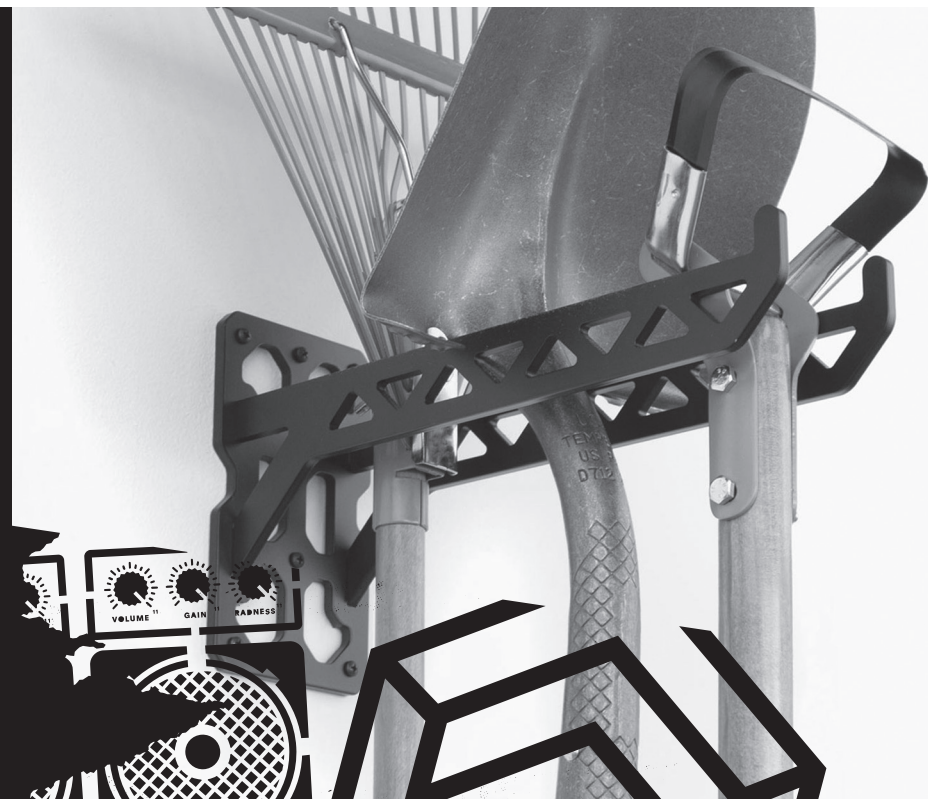







START ↓↓

Study FM Utility Bracket features solid steel with funky powder-coated finishes and boasts a capacity of upwards of 600 lbs when installed correctly. **Made in-house by us in the United States of Awesome. Rad!**

What's In The Box

What You'll Need

Study FM Utility Bracket 1x 	Matching 1/2" Wall Fasteners 8x 	Innate Radness Done! 	Your Favorite Soda 2x 
Wall Anchors 8x 	+	+	+
+	+	+	+
+	+	+	+

CERTIFIED
RAD™

MADE IN THE
U.S. OF A.

LIGHTNING FAST
LEAD TIMES



Installation Steps

001

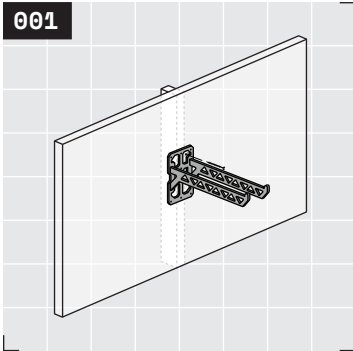

Yo! Here we go! The strength of the Study bracket is maximized when installed on studs or wall blocking, so we recommend utilizing studs or blocking for optimum performance. See **Rad Tip** ☺ on page 7. If you have a stud or blocking available, center your shiny new bracket on studs or wall blocking. Use a drill to fasten a wall fastener into a middle or upper fastener hole location and **proceed to step 4**. However, if any or all fastener locations miss a stud or blocking, **proceed to steps 2 and 3**.

002

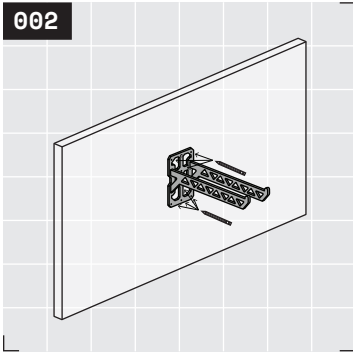

Position bracket in desired location. Use a drill to fasten a wall fastener into a middle or upper fastener hole location and level. Mark the remaining fastener hole locations with a fastener tip or pencil. Crack open and take a swig of your favorite non-alcoholic brew.

003



Remove the bracket from the wall and predrill all holes not backed by studs or blocking with a 1/4" diameter drill bit. Install wall anchors into predrilled holes. Replace bracket on the wall.



004

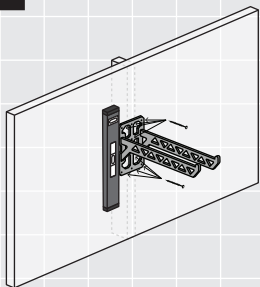

Ensure bracket is level, then install fasteners into fastener hole locations. It is not necessary to utilize all holes, however, at least four locations with solid backing (either studs, blocking, or appropriate wall anchors) are recommended for maximum strength.

005

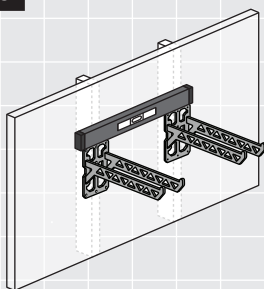

To mount additional brackets aligned with the first, use a level to align both brackets and repeat steps 1-4.

006

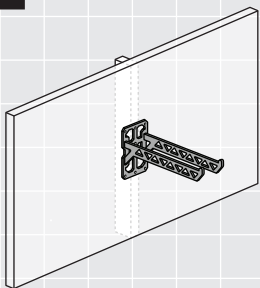

Finish off your soda, it's time to celebrate your innate awesomeness! You finished the shelf install and deserve heaps of adulation. If you need more help, please reach out to a shelf geek today.

hello@shelfology.com
949.244.1083

CERTIFIED
RAD™

MADE IN THE
U.S. OF A.

LIGHTNING FAST
LEAD TIMES



Whoa, you made it! We are vicariously stoking for you right now. Post your sweet shelfie on Instagram now!



Study FM Install Guide
Warnings

@shelfology
#radshelfie

Need a hand? Speak with a Shelf Geek at 949.244.1083 or hello@shelfology.com today.

How did we do? You'll get an email soon asking for a product review, and we'd be stoked if you oblige. You rock in advance!

Warnings



① **Correct Install Required For Safe Use**

1.1 Brackets must be correctly installed into studs or wall blocking. Failure to do so may result in sagging brackets, falling objects, or serious injury.

② **Adhere To The Capacity Rating Of Your Specific Bracket**

2.1 Every Shelfology shelf has been engineered for use with specific capacities. Failure to follow our specified capacity ratings may result in sagging shelves, falling objects, or serious injury. Please reference the Study FM Spec Sheet for more information.

③ **California Proposition 65 Warning**

3.1 This product contains chemicals known to the State of California to cause cancer and birth defects or other reproductive harm. Don't eat this shelf. If you live outside of California, do whatever you want. For more boring information, visit www.p65warnings.ca.gov.

④ **Not For Use In Wet Environments**

4.1 Powder coated carbon steel does not equal waterproof. If water has direct and constant contact with the bracket, like in a shower or outdoors, it will rust. Brackets installed in these conditions are not covered by our warranty.

GET MORE RADMESS NOW AT SHELFLOGY.COM
NEED A HAND? 949.244.1083 // HELLO@SHELFLOGY.COM

Rad Tips



① Fasten Into All Studs & Blocking The Shelf Crosses

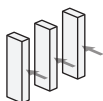

1.1 Studs are the vertical 2x4 boards that make up the bones of your walls. They provide solid structure for your brackets to attach to.

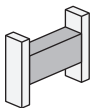

1.2 Blocking is typically added later between studs in the wall for additional support to mount bracket to, and is usually made from 2x4 or 2x6 lumber.



1.3 For a contractor grade install with best substrate strength, install blocking along the length of your bracket.

② Using a Longer Level



2.1 You can turn a short level into a long one by laying it on a straight object like a yard stick. Just hold it on the wall with your bubble level on top and measure!

③ Bracket Spacing

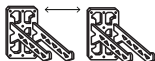

3.1 Bracket spacing is up to you. It's part of Study's insanely cool aesthetic. With that said, these brackets should never be more than 48" apart. Saggy shelves suck!

④ Study As a Shelf System



4.1 To use the Study FM as a shelf system, ensure that the shelf slab depth is cut to fit snugly between the mounting face and end tabs at the end of the bracket.

CERTIFIED
RAD™

MADE IN THE
U.S. OF A.

LIGHTNING FAST
LEAD TIMES

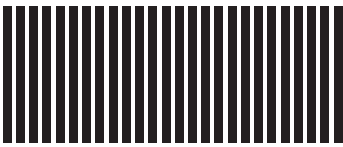

Need a hand? Speak with a Shelf Geek at 949.244.1083 or hello@shelfology.com today.

How did we do? You'll get an email soon asking for a product review, and we'd be stoked if you oblige. You rock in advance!

Call 949.244.1083
Email hello@shelfology.com
Shop www.shelfology.com
Visit 156 N 2nd E Rexburg, ID 83440
Social @shelfology



ON THE—
WALL
DESIGNS
BY OFF
THE WALL
DESIGNERS™

© Shelfology 2024
Printed In The USA