

Shelfology  
Certified Rad\_™

Made In The U.S.A.  
By Woodworkers, For  
Woodworkers\_

→ Patent  
Pending  
Design.

The  
Original  
Bracket.

★ Made  
In The  
USA.

# Aksel System

## Install Guide



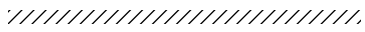

# Installation Difficulty Rating (1-10)

# 7

Table of Contents	Page
Installation Steps	004
Warnings	006
Rad Tips	007

## Required Tools

## Optional Tools

Drill	Level	Pencil	¼" Diameter Drill Bit
Measuring Tape	Phillips-head Screwdriver	Stud Finder	
+	+	+	+
┌	┌┌	┌┌	┌┌
└	└└	└└	└└
+	+	+	+
┌	┌┌	┌┌	┌┌
└	└└	└└	└└









START ↓↓

You're about to level up your space with Aksel, the reigning king of floating shelf systems! Revel in its carefully hand-selected premium hardwood and its uber strong Aksel floating shelf bracket. Made in-house by us in the United States of Awesome. Rad!

### What's In The Box

### What You'll Need

<p><b>Aksel Bracket</b> 1x</p> 	<p><b>Aksel Shelf Slab</b> 1x</p> 	<p><b>Innate Radness Done!</b></p> 	<p><b>Your Favorite Soda</b> 2x</p> 
<p><b>Wall Fastener Set</b> 1x</p> 	<p><b>Wall Anchor Set</b> 1x</p> 	+	+
<p><b>Set Screws</b> 2x</p> 	+	+	+
+	+	+	+

CERTIFIED  
RAD™

MADE IN THE  
U.S. OF A.

LIGHTNING FAST  
LEAD TIMES



# Installation Steps

001

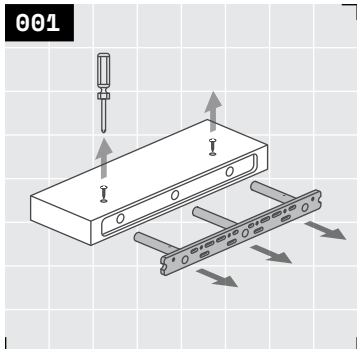

Let's dive in, homies! First, remove set screws. Next, remove Aksel bracket from the back of the shelf. Put shelf and set screws aside.

002

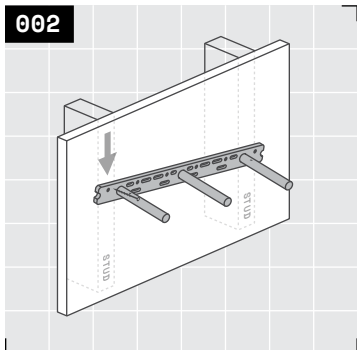

Orient your bracket on the wall so the hole and channel pattern across the top of your bracket face up. Use a drill to install a fastener in either far left or right hole. Level your bracket, set another fastener in the opposite end hole with your drill. If you have installed blocking behind the full length of your bracket, skip to step 5. If you have not installed blocking, proceed to step 3. For more information on blocking, see **Rad Tip** ① on page 7.

003

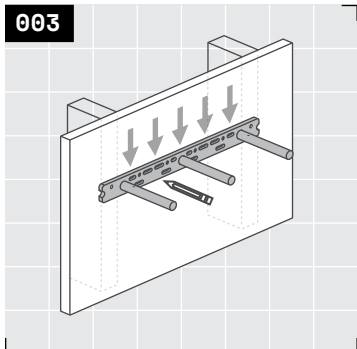

Mark all fastener holes and channels with a pencil. Once every fastener location has been marked, uninstall both fasteners and remove your bracket from the wall. Take a swig of your favorite soda or non-alcoholic brew.



004

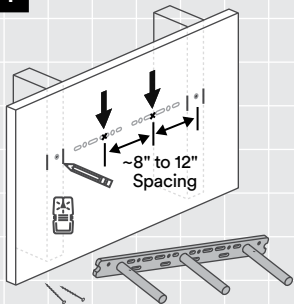

Use a stud finder to mark the location of every stud the bracket crosses. Then for areas between studs, mark one or two drywall anchor install locations roughly every eight to twelve inches (they may be closer if you have additional fasteners), along the length of the bracket depending on the stud spacing in your wall.

005

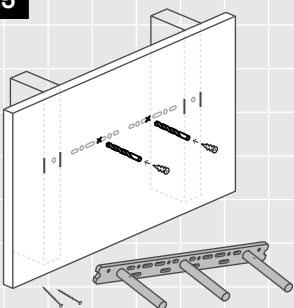

Predrill each drywall anchor location with a 1/4" drill bit to avoid breaking drywall anchors. Install a drywall anchor in each of these pre-drilled locations. If you are using your own anchors, we recommend Toggler brand for best results. Stud locations should not be pre-drilled. Drywall anchors should be installed flush with the drywall surface.

006

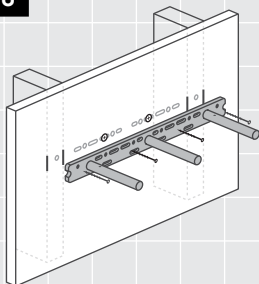

Replace the bracket and install a fastener into every location crossing a stud or blocking. Take another swig of that sweet, sweet soda...you get me?

007

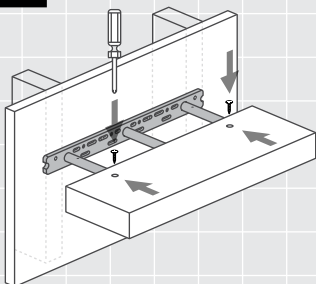

Make a final inspection of your bracket. Check for bracket sag, confirm bracket is correctly secured to wall. To correct sag, see **Rad Tip** © and © on page 7. Slide wood shelf onto bracket. Re-install set screws with phillips screwdriver. Do not use power drill for set screw installation.

Finish off your soda, it's time to celebrate your innate awesomeness! You finished the shelf install and deserve heaps of adulation. If you need more help, please reach out to a shelf geek today.

hello@shelfology.com  
949.244.1083

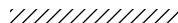



Whoa, you made it! We are vicariously stoking for you right now. Post your sweet shelfie on Instagram now!



@shelfology  
#radshelfie

Need a hand? Speak with a Shelf Geek at 949.244.1083 or hello@shelfology.com today.

How did we do? You'll get an email soon asking for a product review, and we'd be stoked if you oblige. You rock in advance!

## Warnings



① **Correct Install Required For Safe Use**

1.1 Shelf brackets must be correctly installed into studs or wall blocking. Failure to do so may result in sagging shelves, falling objects, or serious injury.

② **Adhere To The Capacity Rating Of Your Specific Bracket**

2.1 Every Shelfology bracket weight class and length has been engineered for use with specific shelf capacities/dimensions. Failure to follow our specified capacity ratings and correct shelf dimensions may result in sagging shelves, falling objects, or serious injury. For more information, reference the Aksel Specifications Sheet.

③ **California Proposition 65 Warning**

3.1 This product contains chemicals known to the State of California to cause cancer and birth defects or other reproductive harm. Don't eat this bracket. If you live outside of California, do whatever you want. For more boring information, visit [www.p65warnings.ca.gov](http://www.p65warnings.ca.gov).

④ **This Product May Make Others Incredibly Jealous**

4.1 Any Shelfology Certified Rad™ product should be flaunted with caution around friends, loved ones, and even complete strangers, as minimal or extreme jealousy may occur. Shelf responsibly.



## ① Fasten Into All Studs & Blocking The Bracket Crosses

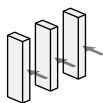

**1.1** Studs are the vertical 2x4 boards that make up the bones of your walls. They provide solid structure for your shelves to attach to.

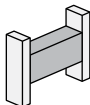

**1.2** Blocking is typically added later between studs in the wall for additional support to mount shelves to, and is usually made from 2x4 or 2x6 lumber.



**1.3** For a contractor grade install with best substrate strength, install blocking along the length of your bracket.

## ② Using Shims With Your Bracket

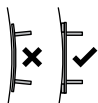

**2.1** If your wall is not straight, use shims to ensure your bracket is installed straight across the wall face and square to the wall. The shelf slab and bracket will properly mate only if the bracket is straight and plumb.

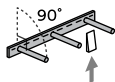

**2.2** If your bracket continues to sag after correct install, use wood shims underneath the backbar to adjust front to back level.

## ③ Optional Fastener Shim Method

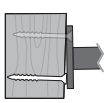

**3.1** As another option, wall fasteners may be installed behind the bracket's bottom channels and used as adjustable shims. These should only be used in locations backed by a stud or blocking. Drywall anchors will not offer enough support once real force is applied.

Once your bracket has been positioned on the wall, simply mark the lower slots with a pencil where they cross a stud or blocking, then remove your bracket and begin installing fasteners in the marked locations.

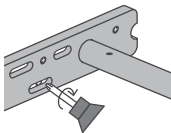

**3.2** Once your bracket is reinstalled over the top of these fastener shims, use your drill to make small adjustments to how proud each fastener head rests.

## ④ Bracket Bar Centerline

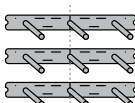

**4.1** Every Aksel bracket has an etched centerline mark in the center-top of the backbar. If you need to center align multiple shelves during an install, you can use a level to create a vertical centerline on your wall and align your brackets to this line.

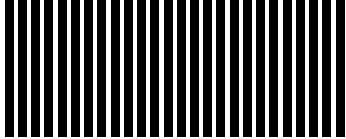

**Need a hand? Speak with a Shelf Geek at 949.244.1083 or hello@shelfology.com today.**

**How did we do? You'll get an email soon asking for a product review, and we'd be stoked if you oblige. You rock in advance!**

**Call** 949.244.1083  
**Email** hello@shelfology.com  
**Shop** www.shelfology.com  
**Visit** 156 N 2nd E Rexburg, ID 83440  
**Social** @shelfology



**ON THE WALL  
 DESIGNS  
 BY OFF THE WALL  
 THE WALL DESIGNERS™**

