

Shelfology  
Certified Rad\_

Designed & Crafted  
By Radically Talented  
Humans Right Here In  
The U.S. Of Awesome\_

→ Patent  
Pending  
Design.

⚡ Lightning  
Fast Lead  
Times.

# Tromso FM

## Install Guide













START ↓↓

Don't be deceived by its sleek + minimal profile: Tromso FM looks like Brooke Shields but packs a He-Man-esque punch with insane weight capacity. **Designed & Crafted By Radically Talented Humans Right Here In The U.S. Of Awesome.**

### What's In The Box

### What You'll Need

<b>Tromso FM Steel Floating Shelf</b> 1x 	<b>Steel Cover Plate (Optional)</b> 1x 	<b>Innate Radness Done!</b> 	<b>Your Favorite Soda</b> 2x 
<b>Truss Head Fastener Set</b> 1x 	<b>Pan Head Fastener Set</b> 1x 	+	+
<b>Wall Anchor Set</b> 1x 	+	+	+
+	+	+	+

DESIGNED & CRAFTED BY RADICALLY TALENTED HUMANS RIGHT HERE IN THE U.S. OF AWESOME.

LIGHTNING FAST LEAD TIMES.

# Installation Steps

001

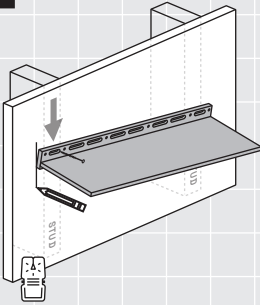

Yo! Here we go! Position your shelf on the wall with the pre-drilled holes along the top edge. Use a drill to fasten either the far left or right hole to the wall in the desired location. Using the slots will allow you to make minor adjustments to the position of your shelf. For masonry installs, see **Rad Tip** ③ on page 7.

002

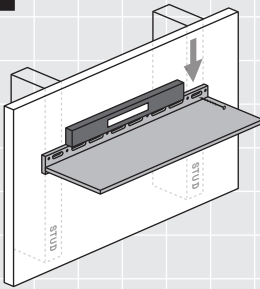

Level your shelf, then set another fastener in the next stud or opposite side with your drill. If you have installed blocking behind the full length of your shelf, **skip to step 6**. If you have not installed blocking, proceed to step 3. For more information on blocking, see **Rad Tip** ① on page 7.

003

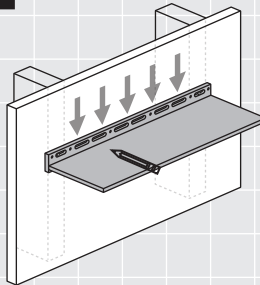

Double check the shelf position on your wall and adjust if necessary. Mark all fastener holes and slots with a pencil. Once every fastener location has been marked, uninstall both fasteners and remove your shelf from the wall. Take a swig of your favorite soda or non-alcoholic brew.



004

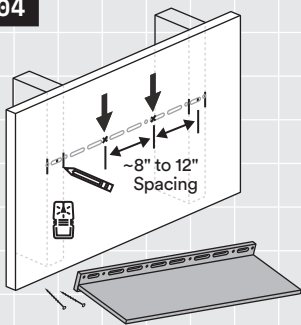

Use a stud finder to mark the location of every stud the shelf crosses. Then for areas between studs, mark a drywall anchor install location roughly every four to six inches along the length of the shelf.

005

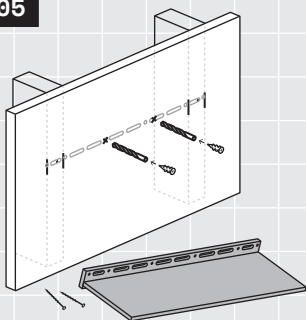

Predrill each drywall anchor location with a 1/4" drill bit to avoid breaking drywall anchors. Install a drywall anchor in each of these pre-drilled locations. If you are using your own anchors, we recommend Toggler brand for best results. Stud locations should not be pre-drilled. Drywall anchors should be installed flush with the drywall surface.

006

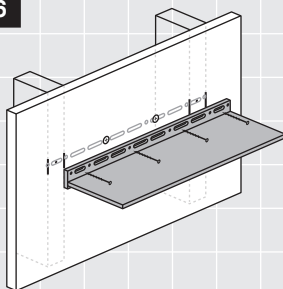

Replace the shelf and install a fastener into every location crossing a stud or blocking. For every location that a drywall anchor was installed, ensure a fully threaded #8 pan head fastener is used. For more information on fasteners, see Rad Tip Ⓞ on page 7.

007

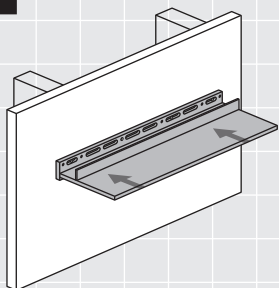

Make a final inspection of your shelf. Check for shelf sag, confirm shelf is correctly secured to wall. See Rad Tip Ⓞ on page 7. If you ordered a cover plate, carefully align to the back-bar and let the magnets snap onto the back-bar. You may need to then slide the cover into correct position. Take care not to pinch your fingers, those magnets are strong!

Stand back and relax, you did it! Give your cat a celebratory fist bump, if present. Gently place your Golden Girls™ box collection on shelf and admire!

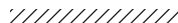

Whoa, you made it! We are vicariously stoking for you right now. Post your sweet shelfie on Instagram now!



@shelfology  
#radshelfie

Need a hand? Speak with a Shelf Geek at 949.244.1083 or hello@shelfology.com today.

How did we do? You'll get an email soon asking for a product review, and we'd be stoked if you oblige. You rock in advance!

## Warnings



① **Correct Install Required For Safe Use**

1.1 Shelves must be correctly installed into studs or wall blocking. Failure to do so may result in sagging shelves, falling objects, or serious injury.

② **Adhere To The Capacity Rating Of Your Specific Shelf**

2.1 Every Shelfology shelf has been engineered for use with specific capacities. Failure to follow our specified capacity ratings may result in sagging shelves, falling objects, or serious injury. Please reference the Tromso FM Spec Sheet for more information.

③ **California Proposition 65 Warning**

3.1 This product contains chemicals known to the State of California to cause cancer and birth defects or other reproductive harm. Don't eat this shelf. If you live outside of California, do whatever you want. For more boring information, visit [www.p65warnings.ca.gov](http://www.p65warnings.ca.gov).

④ **Not For Use In Wet Environments**

4.1 Powder coated carbon steel does not equal waterproof. If water has direct and constant contact with the shelf, like in a shower or outdoors, it will rust. Shelves installed in these conditions are not covered by our warranty.



## ① Fasten Into All Studs & Blocking The Shelf Crosses

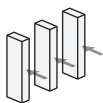

1.1 Studs are the vertical 2x4 boards that make up the bones of your walls. They provide solid structure for your shelves to attach to.

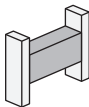

1.2 Blocking is typically added later between studs in the wall for additional support to mount shelves to, and is usually made from 2x4 or 2x6 lumber.



1.3 For a contractor grade install with best substrate strength, install blocking along the length of your shelf.

## ② Using Shims With Your Shelf

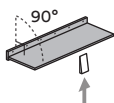

2.1 If your wall is not straight, use shims to ensure your shelf is installed straight across the wall face and square to the wall.

## ③ Masonry Installation

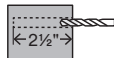

3.1 Hold shelf in position and mark hole placements. Drill each marked location with a 1/4" diameter masonry drill bit. Drill at least 2 1/2" deep to allow for the 2 1/2" wall fastener.



3.2 Using a hammer, tap masonry anchor into hole, flush with wall surface.

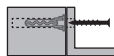

3.3 Hold shelf in position, and install masonry fasteners into anchors.

DESIGNED & CRAFTED BY RADICALLY TALENTED  
HUMANS RIGHT HERE IN THE U.S. OF AWESOME.

LIGHTNING FAST  
LEAD TIMES.

---

Need a hand? Speak with a Shelf Geek at 949.244.1083 or [hello@shelfology.com](mailto:hello@shelfology.com) today.

How did we do? You'll get an email soon asking for a product review, and we'd be stoked if you oblige. You rock in advance!

---

Call 949.244.1083  
Email [hello@shelfology.com](mailto:hello@shelfology.com)  
Shop [www.shelfology.com](http://www.shelfology.com)  
Visit 156 N 2nd E Rexburg, ID 83440  
Social @shelfology

