

Shelfology
Certified Rad™

Designed & Crafted
By Radically Talented
Humans Right Here In
The U.S. Of Awesome_

→ Patent
Pending
✓ Design.

⚡ Lightning
Fast Lead
→ Times.

Skaxsel System

Install Guide













Installation
Difficulty
Rating (1-10)

7

Table of Contents	Page
Installation Steps	004
Warnings	006
Rad Tips	007

Required
Tools

Optional
Tools

<p>Drill</p> 	<p>Level</p> 	<p>Stud Finder</p> 	<p>1/4" Diameter Drill Bit</p> 
<p>Measuring Tape</p> 	<p>Pencil</p> 	<p>3/4" Countersink Bit</p> 	+
<p>Phillips-head Screwdriver</p> 	+	+	+
+	+	+	+

GET MORE RADNESS NOW AT SHELFLOGY.COM
NEED A HAND? 949.244.1083 // HELLO@SHELFLOGY.COM



START ↓↓

Meet Skaksel. Any direction you take it, this mixed-material minimal shelf system will make your space next level! Designed & Crafted By Radically Talented Humans Right Here In The U.S. Of Awesome.

What's In The Box

What You'll Need

Skaksel Bracket 1x	Skaksel Shelf Slab 1x	Innate Radness Done!	Your Favorite Soda 2x
Truss Head Fastener Set 1x	Pan Head Fastener Set 1x		
		+	+
Wall Anchor Set 1x	Set Screws 2x		
		+	+
+	+	+	+

DESIGNED & CRAFTED BY RADICALLY TALENTED HUMANS RIGHT HERE IN THE U.S. OF AWESOME.

LIGHTNING FAST LEAD TIMES.



Installation Steps

001

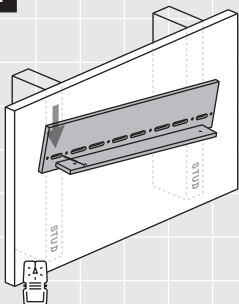

Yo! Here we go! Position your bracket on the wall with the pre-drilled holes and blade along the bottom edge. Use a drill to fasten either the far left or right hole to the wall in the desired location. Using the slots will allow you to make minor adjustments to the position of your bracket. For masonry installs, see **Rad Tip** ③ on page 7.

002

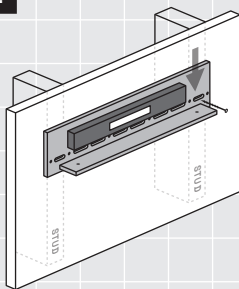

Level your bracket, then set another fastener in the next stud or opposite side with your drill. If you have installed blocking behind the full length of your bracket, **skip to step 6**. If you have not installed blocking, proceed to step 3. For more information on blocking, see **Rad Tip** ① on page 7.

003

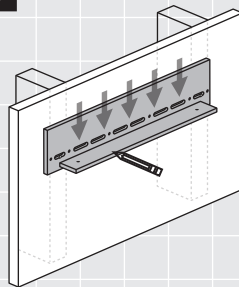

Double check the bracket position on your wall and adjust if necessary. Mark all fastener holes and slots with a pencil. Once every fastener location has been marked, uninstall both fasteners and remove your bracket from the wall. Take a swig of your favorite soda or non-alcoholic brew.

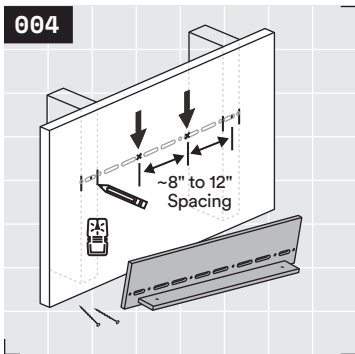

Use a stud finder to mark the location of every stud the bracket crosses. Then for areas between studs, mark a drywall anchor install location roughly every four to six inches along the length of the bracket.

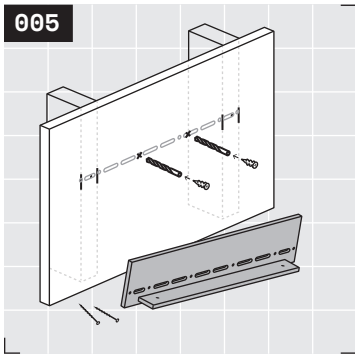

Predrill each drywall anchor location with a 1/4" drill bit to avoid breaking drywall anchors. Install a drywall anchor in each of these pre-drilled locations. If you are using your own anchors, we recommend Toggler brand for best results. Stud locations should not be pre-drilled. Drywall anchors should be installed flush with the drywall surface.

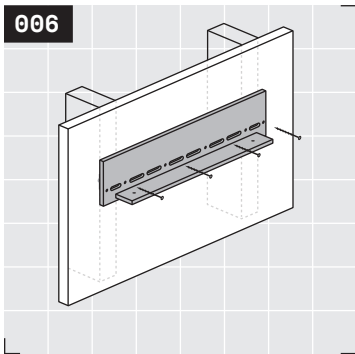

Replace the bracket and install a Truss head fastener into every location crossing a stud or blocking. For every location that a drywall anchor was installed, ensure a fully threaded #8 pan head fastener is used. For more information on fasteners, see Rad Tip ④ on page 7.

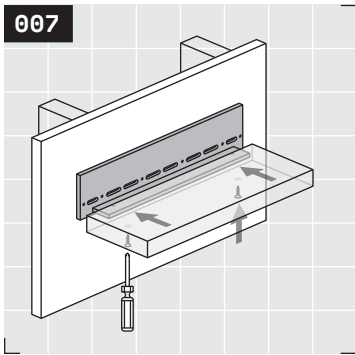

Slide wood shelf onto bracket. Install set screws with phillips screwdriver. **Do not use power drill for set screw installation.**

Make a final inspection of your shelf. Check for shelf sag, confirm shelf is correctly secured to wall. See Rad Tip ② on page 7.

Stand back and relax, you did it! Give your cat a celebratory fist bump, if present. Gently place your D&D box collection on shelf and admire!



Whoa, you made it! We are vicariously stoking for you right now. Post your sweet shelfie on Instagram now!

@shelfology #radshelfie

Need a hand? Speak with a Shelf Geek at 949.244.1083 or hello@shelfology.com today.

How did we do? You'll get an email soon asking for a product review, and we'd be stoked if you oblige. You rock in advance!

Warnings



1 Correct Install Required For Safe Use

1.1 Shelves must be correctly installed into studs or wall blocking. Failure to do so may result in sagging shelves, falling objects, or serious injury.

2 Adhere To The Capacity Rating Of Your Specific Shelf

2.1 Every Shelfology shelf has been engineered for use with specific capacities. Failure to follow our specified capacity ratings may result in sagging shelves, falling objects, or serious injury. Please reference the Skaksel Spec Sheet for more information.

3 California Proposition 65 Warning

3.1 This product contains chemicals known to the State of California to cause cancer and birth defects or other reproductive harm. Don't eat this shelf. If you live outside of California, do whatever you want. For more boring information, visit www.p65warnings.ca.gov.

4 Not For Use In Wet Environments

4.1 Powder coated carbon steel does not equal waterproof. If water has direct and constant contact with the shelf, like in a shower or outdoors, it will rust. Shelves installed in these conditions are not covered by our warranty.



① Fasten Into All Studs & Blocking The Shelf Crosses

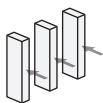

1.1 Studs are the vertical 2x4 boards that make up the bones of your walls. They provide solid structure for your shelves to attach to.

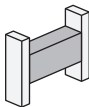

1.2 Blocking is typically added later between studs in the wall for additional support to mount shelves to, and is usually made from 2x4 or 2x6 lumber.



1.3 For a contractor grade install with best substrate strength, install blocking along the length of your shelf.

② Using Shims With Your Shelf

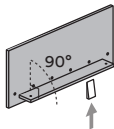

2.1 If your wall is not straight, use shims to ensure your shelf is installed straight across the wall face and square to the wall.

③ Masonry Installation

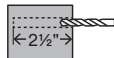

3.1 Hold shelf in position and mark hole placements. Drill each marked location with a 1/4" diameter masonry drill bit. Drill at least 2 1/2" deep to allow for the 2 1/2" wall fastener.



3.2 Using a hammer, tap masonry anchor into hole, flush with wall surface.

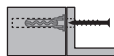

3.3 Hold shelf in position, and install masonry fasteners into anchors.

④ How To Choose Your Fastener Type

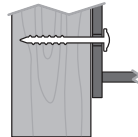

4.1 Truss Head: Use the supplied truss head style wood fasteners in areas that cross studs or blocking with holes and channels that are not countersunk.

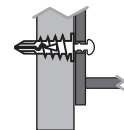

4.2 Pan Head: For drywall or masonry, use the supplied pan head fasteners with the included drywall or masonry anchors.

DESIGNED & CRAFTED BY RADICALLY TALENTED
HUMAN'S RIGHT HERE IN THE U.S. OF AWESOME.

LIGHTNING FAST
LEAD TIMES.

Need a hand? Speak with a Shelf Geek at 949.244.1083 or hello@shelfology.com today.

How did we do? You'll get an email soon asking for a product review, and we'd be stoked if you oblige. You rock in advance!

Call 949.244.1083
Email hello@shelfology.com
Shop www.shelfology.com
Visit 156 N 2nd E Rexburg, ID 83440
Social @shelfology

