

Shelfology
Certified Rad™

Made In The U.S.A.
By Woodworkers, For
Woodworkers_

→ Patent
Pending
Design.

⚡ Lightning
Fast Lead
Times.

★ Made
In The
USA.

Roderick Hanger Hook

Install Guide





Installation
Difficulty
Rating (1-10)

5

Table of Contents	Page
Installation Steps	004
Warnings	006
Rad Tips	007

START ↓ ↓















Featuring 30 color options, Roderick Hanger Hook offers infinite utility. Made in-house by us in the United States of Awesome. Rad!

Required Tools

Optional Tools

What's In The Box

What You'll Need

Drill 	Level 	Stud Finder 	¼" Diameter Drill Bit 	Roderick Hanger Hook 1x 	Magnetic Cover Plate 1x 	Innate Radness Done! 	Your Favorite Soda 2x 
Measuring Tape 	Low-tack Tape 			Bugle Head Fastener Set 1x 	Pan Head Fastener Set 1x 		
Pencil 	½" Diameter Drill Bit 			Wall Anchor Set 1x 			

GET MORE RADNESS NOW AT SHEFFOLOGY.COM // NEED A HAND? 949.244.1083 // HELLO@SHEFFOLOGY.COM



CERTIFIED
RAD™

MADE IN THE
U.S. OF A.

LIGHTNING FAST
LEAD TIMES



Installation Steps

001

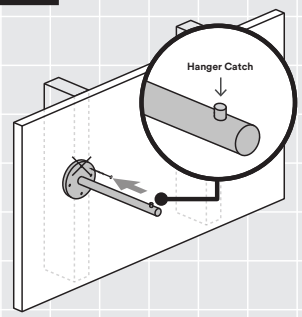

Yo, here we go! Position your Roderick Hanger Hook on your wall, ideally on a stud or blocking. See Rad Tip ① on page 7 if you don't know what blocking is. Rotate hook until hanger catch is oriented vertically. Mark the top-most fastener hole with a fastener tip. Remove your hook from the wall, then grab a can of your favorite non-alcoholic brew and crack it open.

002

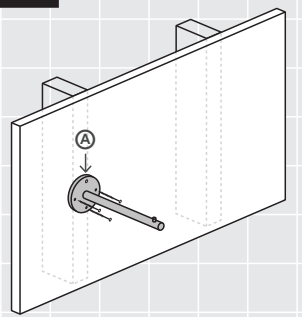

If top and bottom fastener holes are aligned on studs or blocking, install bugle head wall fasteners (A) in the top fastener hole locations. Punch a hole in all remaining fastener locations with fastener tip. See Rad Tip ③ on page 7 to ensure you are using the correct fastener.

003

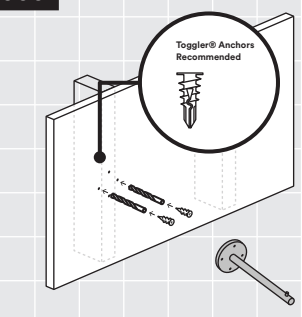

Fastener holes that are not on studs or blocking require a wall anchor. Remove the hook from your wall. Predrill all marked fastener locations not crossing a stud or blocking with a 1/8" drill bit, and install drywall anchors in each fastener hole location crossing drywall. Take a swig of your brew.

004

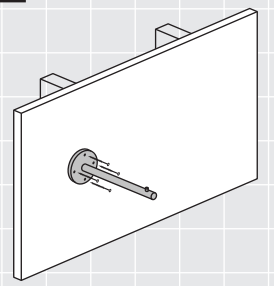

Position the hook, install all wall fasteners. Review Rad Tip ③ on page 7 to ensure you use the correct fastener to get the best function and most strength from of your hook.

005

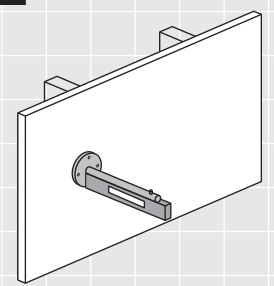

Use a level to check hook for sag. See Rad Tip ② to remove sag. Confirm the hook is secure to the wall.

006

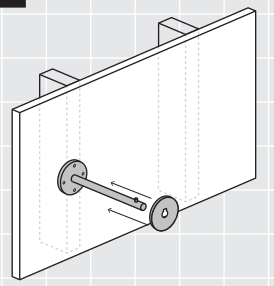

Align the coverplate cutout with the hanger catch. Then, slide the magnetic coverplate onto the rod to cover fastener holes.

We think it looks best to leave the coverplate cutout in the 12 o'clock position in line with the catch, but you can rotate it however you like once it is past the catch.

007

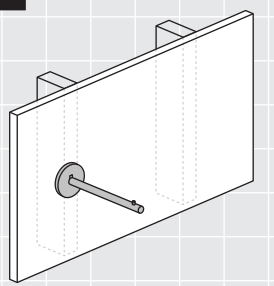

That's it! Finish off your soda, it's time to celebrate your innate awesomeness! If you need more help, please reach out to a shelf geek today.





Whoa, you made it! We are vicariously stoking for you right now. Post your sweet shelfie on Instagram now!

@shelfology
#radshelfie

Need a hand? Speak with a Shelf Geek at 949.244.1083 or hello@shelfology.com today.

How did we do? You'll get an email soon asking for a product review, and we'd be stoked if you oblige. You rock in advance!



Rad Tips

- ① **Fasten Into All Studs & Blocking The Hook Crosses**
- ② **Use Shims to Correct Hook Sag**
- ③ **How To Choose Your Fastener Type**

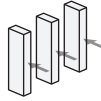

1.1 Studs are the vertical 2x4 boards that make up the bones of your walls. They provide solid structure for your hooks to attach to.

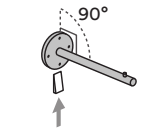

2.1 To remove sag, a shim can be used. If you do not have a wood shim, something solid like a dime or washer can be placed between the wall and the hook edge to raise or lower the rod elevation.

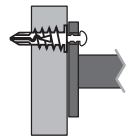

3.1 Pan Head: For drywall or masonry, use the supplied pan head fasteners with the included drywall or masonry anchors.

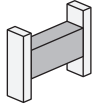

1.2 Blocking is typically added later between studs in the wall for additional support to mount hooks to, and is usually made from 2x4 or 2x6 lumber.

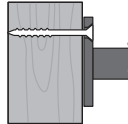

3.2 Bugle Head: Use the supplied bugle head style wood fasteners in areas that cross studs or blocking.

Warnings



- ① **Correct Install Required For Safe Use**
- ② **Adhere To The Capacity Rating Of Your Specific Hook**
- ③ **California Proposition 65 Warning**
- ④ **This Product May Make Others Incredibly Jealous**

1.1 Wall Hooks must be correctly installed into studs, blocking, or the appropriate wall anchors. Failure to do so may result in sagging hooks, falling objects, or serious injury.

2.1 Every Shelfology hook has been engineered for use with specific hook capacities/dimensions. Failure to follow our specified capacity ratings and correct hook dimensions may result in sagging hooks, falling objects, or serious injury. For more information, reference the Roderick Hanger Hook Specification Sheet.

3.1 This product contains chemicals known to the State of California to cause cancer and birth defects or other reproductive harm. Don't eat this hook. If you live outside of California, do whatever you want. For more boring information, visit www.p65warnings.ca.gov.

4.1 Any Shelfology Certified Rad™ product should be flaunted with caution around friends, loved ones, and even complete strangers, as minimal or extreme jealousy may occur. Shelf responsibly.



CERTIFIED
RAD™

MADE IN THE
U.S. OF A.

LIGHTNING FAST
LEAD TIMES



Need a hand? Speak with a Shelf Geek at 949.244.1083 or hello@shelfology.com today.

How did we do? You'll get an email soon asking for a product review, and we'd be stoked if you oblige. You rock in advance!

Call	949.244.1083
Email	hello@shelfology.com
Shop	www.shelfology.com
Visit	156 N 2nd E Rexburg, ID 83440
Social	@shelfology



**ON THE WALL
DESIGNS
BY OFF THE WALL
DESIGNERS™**