

Shelfology
Certified Rad_

Designed &
Engineered In The
U.S. Of Awesome_

→ Patent
Pending
✓ Design.

⚡ Lightning
Fast Lead
→ Times.

Drake Bracket

Install Guide



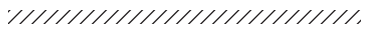

Installation
Difficulty
Rating (1-10)

5

Table of Contents	Page
Construction Method	004
Installation Steps	005
Rad Tips	008
Notes	009
Warnings	011

Required Tools

Optional Tools

Drill	Level	Pencil	Buddy/Pal
	+	+	+
	+	+	+
	+	+	+
	+	+	+

GET MORE RADNESS NOW AT SHELFLOGY.COM
NEED A HAND? 949.244.1083 // HELLO@SHELFLOGY.COM



START ↓↓

Stoke the neighbors
when you show
off any stone slab
levitating in space on
a Drake. Designed &
Engineered In The U.S.
Of Awesome. Rad!

What's In The Box

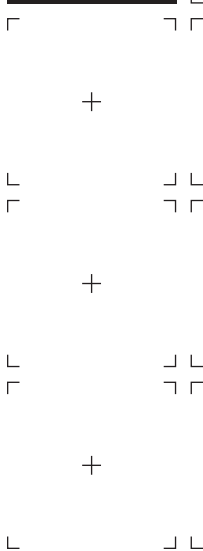

What You'll Need

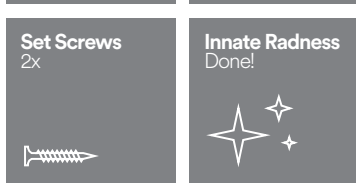

DESIGNED & ENGINEERED IN
THE U.S. OF AWESOME.

LIGHTNING FAST
LEAD TIMES.



Construction Method

① Pick Your Depth

② Use Any Countertop Style

③ Hold Massive Weight

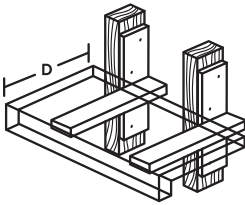

Rated for use with solid rock, granite and concrete slabs, this is ideal for kitchen counter or bathroom vanity applications requiring floating surfaces.

Weight capacity varies by countertop depth, mounting surface and the number of fasteners secured through the bracket. Brackets must be installed correctly into studs and blocking. See Figure 1 below.

Bracket Rod Length	Countertop Depth (D)
8"	9"-12"
12"	13"-16"
16"	17"-20"
20"	21"-24"

Figure 1: Drake Bracket Weight Capacity

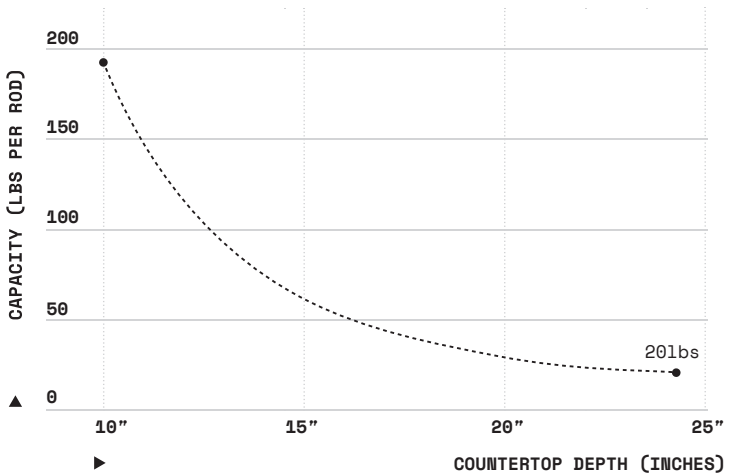



Installation Steps

001

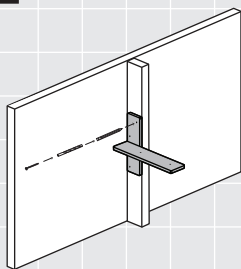

Yo, here we go! Position your first bracket on a stud or post in the desired location. Mark top hole with a pencil, then predrill with a $\frac{1}{8}$ " drill bit. See **Rad Tip** ① on page 8. Install a $\frac{1}{4}$ " lagscrew through bracket into hole.

002

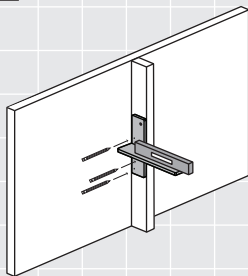

Straighten the bracket using a level. Mark remaining fastener hole locations with a fastener tip or a pencil.

003

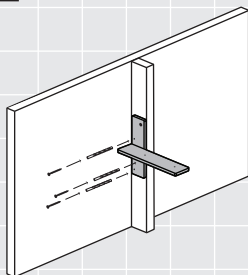

Remove bracket, predrill marked locations with a $\frac{1}{8}$ " drill bit. Install a second lagscrew into marked location. Recheck for level. Reinstall $\frac{1}{4}$ " lagscrews into remaining holes.



004

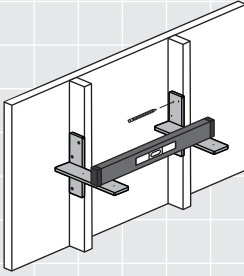

After installing first bracket, hold second bracket in position (brackets for countertops should never be more than 48" apart). Use a level to align both brackets horizontally. Mark an upper fastener hole location for the second bracket. See **Rad Tip**® on page 8.

005

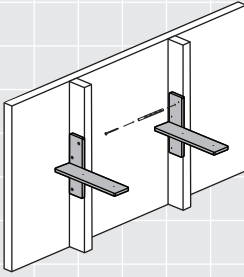

Pre-drill and install 1/4" lagscrew in marked location. Repeat steps 2 and 3. Once you have installed all brackets, you are ready for drywall.

006

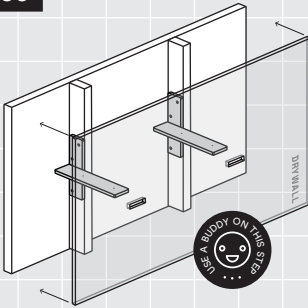

To finish your installation, measure and cut holes in your drywall or wall sheeting large enough to accept the bracket supports. Move wall sheeting into place around brackets and secure it to the wall.

007

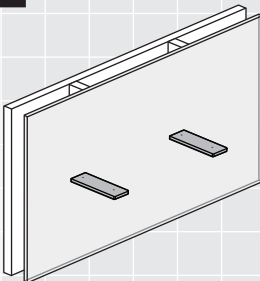

If needed, seal gaps around bracket supports with drywall joint compound. See **Rad Tip**® on page 8. Texturing and painting the wall surface behind the countertop slab is recommended before countertop installation.



008

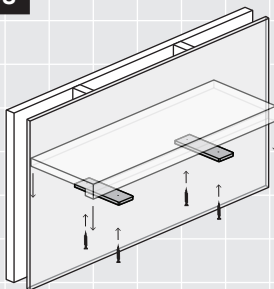

Position countertop slab. See Rad Tip ④ on page 8 for slab recommendations. Install set screws into countertop to secure it in place.

009

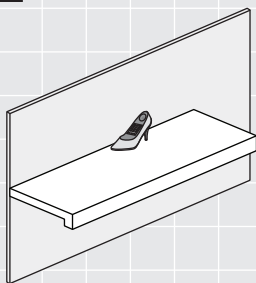

You are done! give your cat a celebratory fist bump if present. Gently place your authentic 1980's high-heel shoe phone on countertop and admire.

Whoa, you made it! We are vicariously stoking for you right now. Post your sweet shelfie on Instagram now!

@shelfology
#radshelfie

Need a hand? Speak with a Shelf Geek at 949.244.1083 or hello@shelfology.com today.

How did we do? You'll get an email soon asking for a product review, and we'd be stoked if you oblige. You rock in advance!



DESIGNED & ENGINEERED IN
THE U.S. OF AWESOME.

LIGHTNING FAST
LEAD TIMES.



Rad Tips



① Fasten into Studs

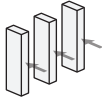

1.1 The Drake bracket is designed to be mounted on a fixed stud, post, or other structural surface. Drywall is not structural, and will not support this bracket.

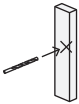

1.2 Predrilling a $\frac{1}{8}$ " pilot hole in the desired lagscrew location will ensure accurate screw placement, and prevent splitting of the stud or post.

② How to Make a Longer Level

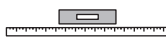

2.1 You can turn a short level into a long one by laying it on a straight object like a yard stick. Just hold it in place with your bullet level on top and measure!

③ Protecting the Finish

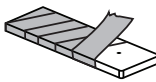

3.1 Covering the bracket support rod with low-tack removable tape will protect the finish during drywall installation, sanding, and painting. Remove tape before installing countertop.

3.2 To secure your slab to the brackets, we recommend drilling at least two vertical holes in each support rod with a $\frac{3}{16}$ " drill. Install set screws through these locations.

④ Slab Thickness

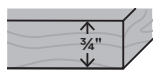

4.1 At least $\frac{3}{4}$ " thick solid hardwood, or manufactured countertop slab is recommended to avoid sag. See visit us at shelfology.com, or call **949-244-1083** to order slabs made to measure.



Notes

A large grid of dotted lines for taking notes, consisting of approximately 25 columns and 30 rows.

Warnings



① Correct Install Required For Safe Use

1.1 Countertop brackets must be correctly installed into studs or wall blocking. Failure to do so may result in sagging countertops, falling objects, or serious injury.

② Adhere To The Capacity Rating Of Your Specific Bracket

2.1 Every Shelfology bracket weight class and length has been engineered for use with specific capacities/dimensions. Failure to follow our specified capacity ratings and correct countertop dimensions may result in sagging countertops, falling objects, or serious injury.

③ California Proposition 65 Warning

3.1 This product contains chemicals known to the State of California to cause cancer and birth defects or other reproductive harm. Don't eat this bracket. If you live outside of California, do whatever you want. For more boring information, visit www.p65warnings.ca.gov.

④ This Product May Make Others Incredibly Jealous

4.1 Any Shelfology Certified Rad™ product should be flaunted with caution around friends, loved ones, and even complete strangers, as minimal or extreme jealousy may occur. Shelf responsibly.

DESIGNED & ENGINEERED IN
THE U.S. OF AMESOME.

LIGHTNING FAST
LEAD TIMES.

Need a hand? Speak with a Shelf Geek at 949.244.1083 or hello@shelfology.com today.

How did we do? You'll get an email soon asking for a product review, and we'd be stoked if you oblige. You rock in advance!

Call 949.244.1083
Email hello@shelfology.com
Shop www.shelfology.com
Visit 156 N 2nd E Rexburg, ID 83440
Social @shelfology

